



## Web-Server

For LPB/BSB plants

## OZW672... V8.0

Web server OZW672... allows for remote plant control and monitoring via the web and Smartphone-App. Web server is available in three versions: To connect 1 LPB/BSB unit or 4 or 16 LPB units for the Sigmagyr / Albatros and Albatros2 ranges.

- Operate via web browser with PC/laptop and Smartphone
- Operate via Smartphone app (iPhone and Android)
- Operation via Internet portal with auxiliary functions
- Plant visualization in the web browser based on customized plant web pages
- Connection types: USB and Ethernet
- 2 digital inputs for fault messages
- Display fault messages in the web browser
- Send fault messages to a maximum of 4 e-mail recipients
- Periodically send system reports to maximum of 4 e-mail recipients
- Create trends, trend graphs and send trend data to 2 e-mail recipients
- Function "Energy indicator" to monitor data points for energy-related limit values, or "Green limits" and send to 2 e-mail recipients

- **Web services for external applications via Web API (Web Application Programming Interface)**
- **Encrypted with https and TLS for emails**
- **ACS790 functionality**
- **Secure tunnel connection for ACS via portal**
- **Time sync via NTP network time server**

## Use

---

### Buildings

- Apartments in single and multi-family homes.
- Office and administrative buildings, residential housing.
- Schools, gymnasiums, leisure facilities, hotels.
- Municipal buildings, commercial and smaller industrial buildings.

### Owners/operators

- End customers, HVAC and electrical installers, heating manufacturers.
- Real estate agencies, real estate management companies, service organizations.
- Building maintenance companies, facility management.

## Functions

---

### Commissioning

Commissioning is carried out via PC/Laptop and Web browser or ACS.  
A quick commissioning mode is available on plants with only a single connected controller.

### Web operation

- Remotely operate and monitor plants and devices on a LPB/BSB network using a web browser on PC/laptop and Smartphone.
- Access via Internet portal or direct connection
- Simultaneous support of multiple users.
- User accounts for web operation (user groups, operating language).
- Set up customized plant web page features.

### Access via portal

Siemens offers with the Climatix IC / Synco IC Internet portal simple and secure access to web servers (available as of web server version 5.2).

### Benefits

- Simple and fast set up of access via the Internet – neither a fixed IP address, nor forwarding of a dynamic IP address, nor port forwarding (NAT/PAT) is required
- The portal provides additional functions:
  - Manage one or multiple plants
  - Central user management
  - Display of plant overview, state of Energy indicators, and alarms
  - Plant functional scope can be set for various plant roles
  - Logging fault messages as common faults
  - Send alarm notifications per e-mail
  - Secured communications through encryption (https)

### Access without portal (direct connection)

The web server can be accessed directly via the Internet (without using the portal). A fixed IP address to the web server is required or a dynamic IP address with forwarding via a dynamic DNS server. In addition, the port forwarding must be configured on the router.

A direct connection in parallel to the portal is also possible.

## Web interface

The web server interface is the same using the portal or via a direct connection. The portal has, however, additional functions and available settings.

## User interface portal

The screenshot shows the Siemens web interface portal. The top navigation bar includes 'Dashboards', 'Operating', and 'Administration'. The user is logged in as 'name@example.com'. The main content area displays the 'Ethernet' settings for device '0.6 OZW672.16'. The settings are organized into two sections: 'Datapoint' and 'Set when DHCP client off'. Each section contains a table of network parameters.

Datapoint	Value
DHCP client	On
IP address	192.168.2.43
Subnet mask	255.255.255.0
Default gateway	192.168.2.1
Preferred DNS server	192.168.2.1
Alternate DNS server	
Set when DHCP client off	
IP address	192.168.2.10
Subnet mask	255.255.255.0
Default gateway	192.168.2.1
Preferred DNS server	192.168.2.1
Alternate DNS server	

Click the symbol to open the web server user interface under a new tab and is then the same as the view under a direct connection.

The portal symbol and e-mail address is displayed in place of the user symbol and user name.

## User interface web server (Direct connection)

The screenshot shows the Siemens web interface web server (Direct connection). The top navigation bar includes 'Home', 'Energy indicator', 'Faults', 'File transfer', 'User accounts', and 'Device web pages'. The user is logged in as 'Administrator'. The main content area displays the 'Ethernet' settings for device '0.6 OZW672.16'. The settings are organized into two sections: 'Datapoint' and 'Set when DHCP client off'. Each section contains a table of network parameters.

Datapoint	Value
DHCP client	On
IP address	192.168.2.43
Subnet mask	255.255.255.0
Default gateway	192.168.2.1
Preferred DNS server	192.168.2.1
Alternate DNS server	
Set when DHCP client off	
IP address	192.168.2.10
Subnet mask	255.255.255.0
Default gateway	192.168.2.1
Preferred DNS server	192.168.2.1
Alternate DNS server	
Physical address	00:a0:03:fd:27:f0

## Primary navigation

Primary navigation offers the following functions:

Home	Menu-based plant and device operation.
Energy indicator	Display and operate "Energy indicator" data points. (displayed only if a controller is connected with an Energy indicator)
Faults	Display system faults.
File transfer	Create and manage trend functions Download consumption data and event history, Upload documents, logos and system definitions as well as firmware update.
User accounts	User administration.
Device web pages	Create device list and operating pages.

## Secondary navigation

The secondary navigation (menu tree) allows users to select devices and operating pages.

## Display

The display range displays content corresponding to the selected primary and secondary navigation.

## Plant state

The display indicates no fault or the most serious plant fault depending on plant state.

## Faults

### Fault sources

The web server recognizes failures and fault signals from LPB/BSB devices contained in the device list. Faults from digital inputs and own faults are detected also.

### Fault indication

The LED  signals a fault on the web server. The LED is lit for as long as the fault is present.

### Fault status message

Fault status messages can be sent as an e-mail to as many as 4 e-mail recipients and/or via a service provider to SMS recipients. You can set the fault priority for each email recipient (urgent/all). Each receiver has a "Time switch with calendar" to program three sending times per day and holidays/special days.

### Common fault

On the Climatix IC/Synco IC Internet portal, faults are logged as common faults. The portal sends alarm notifications to the defined e-mail addresses in the event of a common fault.

## System report

**System messages** The web server generates system reports and periodically sends the system state to e-mail recipients. Messages are sent as per the set time (hh:mm), the message cycle interval (1...255 days), and priority (urgent/non-urgent).

**Connection test** Press the ✓ button on the web server to send a system report to all defined email recipients regardless of fault priority.

**History** The last 500 fault events, fault messages and system reports are entered in the web server's circular message buffer. The events or history data can be read via web browser.

**Time** The web server has a system clock with adjustable daylight saving/standard time changeover. It can send the time (date and time) as the time clock master to the LPB devices (time clock slave).  
For the system clock, the NTP network time server can perform the time synchronization and, if used as a time clock master, forward the data to all KNX devices (time clock slaves).

**Updates** We differentiate between the following:

- System definition updates to integrate device descriptions of new devices in the web server.
- Firmware updates to update the web server to the latest firmware version. The user settings and system definitions remain as part of a firmware update.
- Factory update to the web server to the latest version and load the latest system definitions. User settings are lost as part of a factory update.

A system definition update and the firmware update requires one simple action via the web browser.  
Operator actions on the web server are required for the factory update. Procedures are communicated when a factory update is issued.

**ACS790** The web server is compatible with the service and operating software ACS790 version 10.00 and higher.

**Secured connection via portal** On web servers as of V7.0, you can establish a secure connection to the web server with the ACS790 and the "Remote Tool Access" software via the Climatix IC / Synco IC portal.

## Visualize plants

Web server OZW672... allows for visualizing technical equipment in buildings via plant web pages. For example, a plant web page can be set up visualizing a plant with data points (max. 100 data points per plant web page) on a floor plan.

In the event of a fault, users can quickly access the impacted locations.

For writable parameters, users can click to open a dialog box and change the parameter (as e.g. the "Room temp reduced setpoint" displayed below).

## Example Plant web page for heating plant

The screenshot shows a Siemens plant web page for a heating plant. The page features a navigation menu on the left with 'Alarms', 'Web access', and 'Documentation'. The main content area displays a technical diagram of a heating system with various components like pumps, valves, and temperature sensors. A dialog box is open over the diagram, allowing the user to change the 'Dhw operating mode' from 'On' to 'Off'. The page includes a header with the Siemens logo, user information, and navigation tabs for 'Dashboards', 'Operating', and 'Administration'. The main content area displays the plant diagram with real-time data points such as 78 °C, 32.0 °C, 22.0 °C, 25.4 °C, 55.0 °C, 45.1 °C, and -3.1 °C. The diagram also shows the status of various components like 'Heat circuit 1 operating level' and 'Heat circuit 1 operating mode on controller'.

## Import plant diagrams

For standard LPB/BSB controller applications, web-capable plant diagrams can be exported from ACS790 and imported in the web server.

## Create own plant web pages

You can freely design plant web pages. As a hybrid form, you can also modify and extend downloaded plant diagrams.

## Web page elements

Users can also embed additional data in a plant diagram such as links to plant, function and maintenance descriptions or data sheets. Moreover, users can integrate external links allowing, for example, to directly browse multiple plants. Users can embed current webcam images in a plant diagram.

## Trend function

The trend function in Web-Server OZW672... can be directly defined on Web server version 5.0.

Using the trend functions, you can log and query any number of data points from connected devices as a selectable sample rate.

## Trend channels

5 trend channels are available. Each trend channel can contain up to 100 data points. The trend channel can be labeled using a free text name.

## Sample rate

The sample rate can be individually created for each trend channel. Available sample rates ranging from 1 s up to 24 hours.

The shortest possible sample rate over all 5 trend channels is 1 data point per second.

## Trend period

RAM size determines possible trend periods for a channel. The trend period varies with the number of selected data points and their sample rates.

Examples for various trend channels:

Interval	Data points	Trend period	
		Channel 1	Channel 2...5
1 sec	1	14 days	1.8 days
5 sec	5	30 days	4.3 days
1 min	10	210 days	30 days
15 min	100	371 days	53 days

Trend channel 1 has 7 times the available memory for long-term trends or trends with a lot of data points or a short sample interval.

## Synchronization

Trends are synchronized to simplify evaluation of trend data. The various query intervals for the trends are placed on an interval grid.

## Operation

The web browser or ACS tool is used to create and manage trend functions.

The screenshot displays the Siemens Web Server OZW672... interface. At the top, the Siemens logo is visible. Below it, the system ID 'OZW672.01' and the date/time '31.01.2018 14:27' are shown. A navigation bar includes links for Home, Energy indicator, Faults, File transfer, User accounts, and Device web pages. A user menu shows '[Logout] Admin'. The main content area is titled 'Trend' and contains a table of active trend functions. The table has columns for Name, State, Query interval, Circular logging, Bus load, and Action. Five trends are listed: Outside temperature (2m query interval, >730 Days circular logging, 1% bus load), Roomtemp setpoint (5m query interval, 728 Days circular logging, 0% bus load), Room temperature (5m query interval, 728 Days circular logging, 0% bus load), DHW setpoint (10m query interval, >730 Days circular logging, 0% bus load), and DHW temperature (10m query interval, >730 Days circular logging, 0% bus load). A 'Current bus load' indicator shows 2%.

Name	State	Query interval	Circular logging	Bus load	Action
Outside temperature	Running	2m	>730 Days	1 %	[Action]
Roomtemp setpoint	Running	5m	728 Days	0 %	[Action]
Room temperature	Running	5m	728 Days	0 %	[Action]
DHW setpoint	Running	10m	>730 Days	0 %	[Action]
DHW temperature	Running	10m	>730 Days	0 %	[Action]

Data query per web browser

A web browser allows you to download trend data for each channel and view it in a spreadsheet program or text editor. A calendar function allows limiting trend data to the desired period within trending.

Web server can be accessed locally or via the Internet.

Trend graph

Data for a trend channel can be graphically displayed on the web user interface. The function is available for OZW672... as of version 6.0.

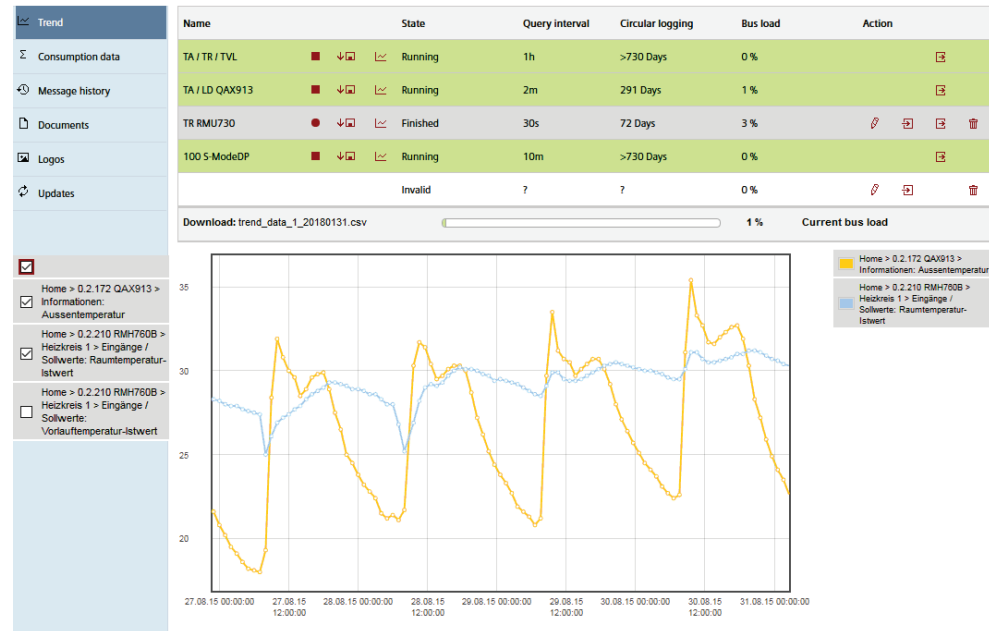

Data transmission per e-mail

2 e-mail recipients can be defined for trend data. Each trend channel can send its data to one or both e-mail recipients.

The send interval can be individually set for each trend channel.

Import/export

Trend definitions can be imported to web server or exported from the web server.



**Function**  
**"Energy indicator"**

Function "Energy indicator" is available on the OZW672... web server from V4.0.

The web server uses the "Energy indicator" function to read selected data point values from the LPB and BSB bus devices and to compare the values to energy-related limit values, or so-called "Green limits".

The data points are also monitored for adherence to the "Green limits". As a result, the "Energy indicator" is displayed in the form of a tree leaf.

**Note**

The "Green limits" are used only together with the "Energy indicator" function. They do **not** represent process or safety limit values which trigger e.g. fault messages or turn off the plant in the event of limit violations.

**Web server, e-mail**

The "Energy indicator" can regularly send its information (set via the web server) to a maximum of 2 e-mail recipients.

**Tree leaf as**  
**"Energy indicator"**

Green leaf 

"Green leaf" → Green tree leaf, leaf pointing up.

- The "Green leaf" symbol indicates that a data point value has not exceeded its "Green limit", i.e. the value is within a "green" range in terms of energy consumption.

Orange leaf 

"Orange leaf" → Orange tree leaf, leaf pointing down.

- The "Orange leaf" symbol indicates that a data point value has exceeded its "Green limit", i.e. the value is outside a "green" range in terms of energy consumption.

**Standard EN 15232**



The "Energy indicator" function is based on standard EN 15232 "Energy efficiency in buildings".

**Example: Web page**  
**"Energy indicator"**

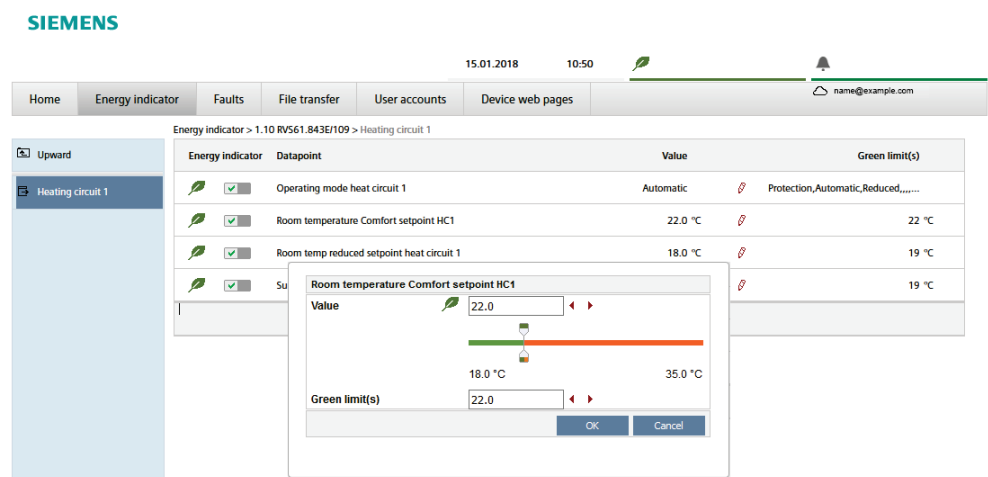
Web page with "Energy indicator" function; example with data points from "Heat circuit 1" and open dialog box to set data point value "Room temperature Comfort setpoint HC 1" and its "Green limit".







**SIEMENS**

15.01.2018 10:50   name@example.com

Home Energy indicator Faults File transfer User accounts Device web pages

Energy indicator > 1.10 RV561.843E109 > Heating circuit 1

Energy indicator	Datapoint	Value	Green limit(s)
	<input checked="" type="checkbox"/> Operating mode heat circuit 1	Automatic	Protection,Automatic,Reduced,.....
	<input checked="" type="checkbox"/> Room temperature Comfort setpoint HC1	22.0 °C	22 °C
	<input checked="" type="checkbox"/> Room temp reduced setpoint heat circuit 1	18.0 °C	19 °C
	<input checked="" type="checkbox"/> Su		19 °C

**Room temperature Comfort setpoint HC1**

Value  22.0

18.0 °C  35.0 °C

Green limit(s) 22.0

OK Cancel

## Web services

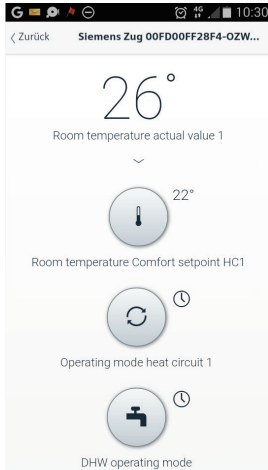

The "Web Application Programming Interface" (Web API) is an interface to make web services on a web server accessible to clients.

All Web API functions are called up via "http" or encrypted "https". Each session begins with authentication on the web server.

If the "HomeControl IC" App installed on a smart phone, the web services can access the data points of the devices on the LPB network via the Web API (communication connection for smart phone see page 11).

## Type summary

---

Name		Product number
Web server	for 1 LPB/BSB device	OZW672.01
Web server	for 4 LPB devices	OZW672.04
Web server	for 16 LPB devices	OZW672.16

## Ordering and delivery

---

When ordering, please specify the name and **product number**.

Example: Web server **OZW672.16**

The web server is delivered in a cardboard box.

The following is included in the package:

- Mounting instructions M5712xx.
- Power cable, power supply AC 230 V.
- Ethernet cable.
- USB cable.
- 2 cable ties.

## Equipment combinations

---

### LPB/BSB devices

The following devices from the Sigmagr/Albatros product range can be connected to each OZW672... web server via LPB/BSB.

- Heating controllers RVL4.., RVP3..
- District heating controller RVD2..
- Universal controller RVP5..
- Heating controllers RVA.., RVS.., RVC..
- Boiler management units LMU.., LMS..

### Note

Download a detailed list of compatibility of LPB/BSB devices from <https://support.industry.siemens.com/cs/ww/en/view/62567396>.

## Product documentation

---

	Document type	Document no.
Web server OZW672...	Data sheet (this document)	N5712
	Mounting instructions (package insert)	M5712
	Installation instructions	G5711
	Commissioning instructions	C5712
	CE declaration of conformity	T5711
	Environmental product declaration	E5711
ACS790 software	Data sheet	N5649

## Technical design

---

### Web browser

Devices	Demand
PC/Laptop (1024 x 786)	html5 compatible web browser
Smart phone	Specific to the particular end device

### Concurrent operation

Concurrent operation is unlimited. The maximum data throughput is shared between the users. Operation slows down as the number of users increases accordingly.

**Operation, monitoring, alarming**

Communication connections for local commissioning (USB) and remote operation, remote monitoring and alarming via Ethernet.

The web server is not suited for direct connection to the Internet, but rather must be connected via a firewall. A router typically includes a firewall.

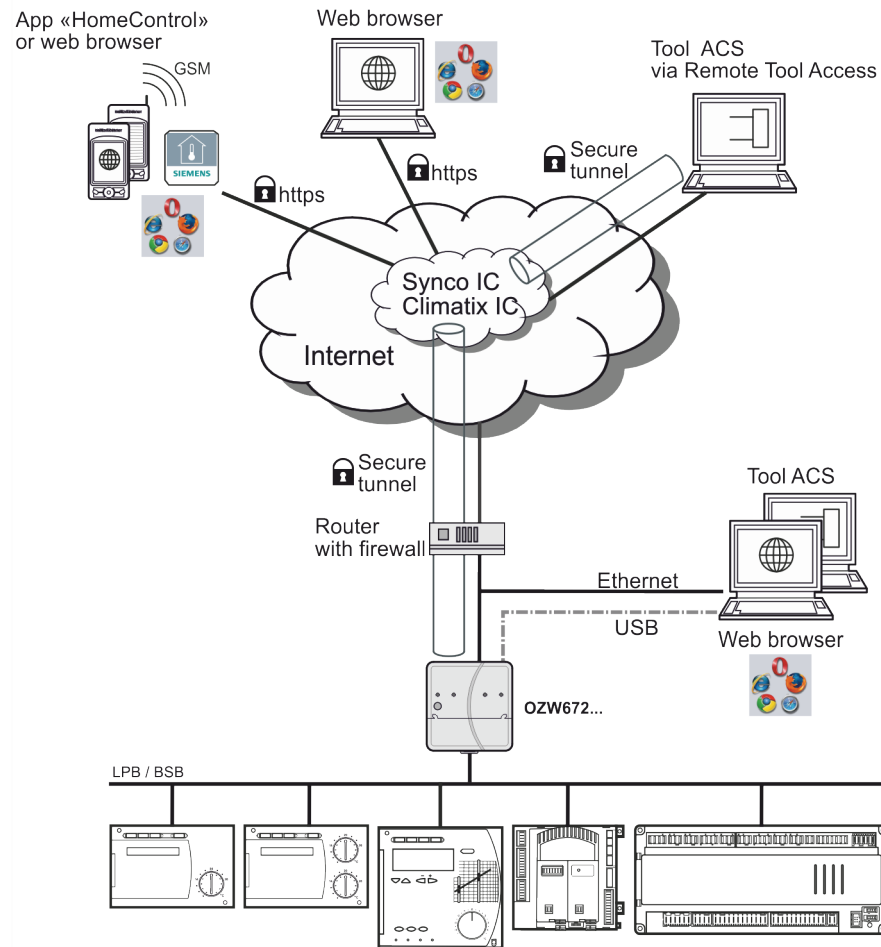

5712Z105

## Interfaces

USB	The USB interface directly connects the PC/laptop on site. The required USB cable type A – type Mini-B is delivered with the device.
Ethernet	The router/network is connected to the Ethernet RJ45 plug. The Ethernet interface features Auto-MDI(X) for crossed and non-crossed Ethernet cables. An Ethernet category 5 cable is supplied.
LPB/BSB	The LPB/BSB bus is connected to terminals DB/CL+ and MB/CL- . For information on the LPB/BSB bus, see Local Process Bus System Engineering, basic documentation P2370.
Digital inputs	The digital inputs D1, D2 help connect potential-free status contacts. They work as fault inputs.

## Protocols

Web operation	<p>Web operation <b>via portal</b> takes place through an HTTPS encrypted connection (Port 443) via TCP/IP. The required certificate is accredited.</p> <p>Web operation <b>without portal</b> takes place through an HTTPS encrypted connection (Port 443) via TCP/IP. The required certificate is not accredited. The self signed certificate by Siemens is saved to the web server and cannot be changed.</p> <p>In addition, an HTTP (Port 80) connection is supported. Port 80 is disabled as delivered. The access via http is not secured. The user is responsible for enabling Port 80.</p> <p>A RNDIS driver on the PC/laptop is required for USB communication. The RNDIS driver is already included in the Windows operating systems for web server as of version 7.0.</p>
Send email	Fault messages and "Energy indicator" reports and trend files are sent in an email via SMTP. The email is encrypted using TLS if supported by the mail server.
DHCP client	The web server can be manually configured or take over its network configuration as a client of a DHCP server.

**Design**

The web server consists of the housing lower section with printed circuit boards and interfaces as well as connection terminals. The upper housing section contains the printed circuit boards. The upper housing section contains the LED displays and one operating button. The connection terminals and additional display and operating elements are located under the removable cover for the upper housing section. All display and operating elements are labeled.

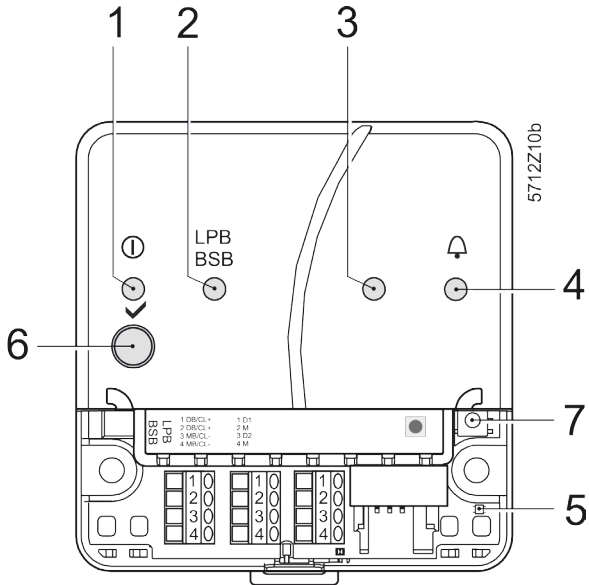

Pos	Element	Designation
1	⓪ LED (red / green / orange)	On-LED Operation, portal connection display and "Energy indicator"
2	LED (green)	LPB/BSB
3	LED	No function
4	⚠ LED (red)	Fault LED
5	LED (red / green)	Quick commissioning LED
6	✓ Button	Remote button
7	⊙ Button	Service button

**LED indicators**

1 ⓪ (red/green/orange)	• Off	No power
	• Red on	Web server is starting the operating system
	• Flashing red	Web server starting the application
	• Green on	Web server operational, Energy indicator = Green leaf
	• Orange on	Web server operational, Energy indicator = Orange leaf
	• Flashing green / orange	Web server operational, connected to the portal (LED 0.8 s on, 0.2 s off)
2 LPB/BSB (green)	• Off	No bus power
	• On	LPB/BSB operational
	• Blinking	Communication on LPB/BSB
3 (LED)		No function
4 Faults ⚠ (red)	• Off	No fault (normal operating state)
	• On	Fault
5 Quick commissioning	• Off	Normal operating mode
	• Flashing green	Quick commissioning active (LED 1 s on, 1 s off)
	• Green on	(for 10 s) device 0.1 or 1 is connected
	• Red on	(for 10 s) device 0.1 or 1 is not connected

## Operating buttons

- |                    |                                                                                              |                                                                                                                  |
|--------------------|----------------------------------------------------------------------------------------------|------------------------------------------------------------------------------------------------------------------|
| <b>6 Remote</b> ✓  | <ul style="list-style-type: none"><li>• Long (&gt; 6 s)</li></ul>                            | Sends system reports to the email recipient of the fault (not to Energy indicator and trend data recipient)      |
| <b>7 Service</b> ◻ | <ul style="list-style-type: none"><li>• Short (&lt; 2 s)</li><li>• Long (&gt; 6 s)</li></ul> | State query device 0.1 (LPB) or 1 (BSB)<br>Quick commissioning of plants with only a single connected controller |

## Button combination

- |         |                                                                   |                                                                                                                                                                                                                                                 |
|---------|-------------------------------------------------------------------|-------------------------------------------------------------------------------------------------------------------------------------------------------------------------------------------------------------------------------------------------|
| ✓ and ◻ | <ul style="list-style-type: none"><li>• Long (&gt; 6 s)</li></ul> | Simultaneously press buttons ✓ and ◻ to restore the device to the factory settings.<br><b>!</b> : All configuration data and settings are reset. The device list, plant diagrams, and unsent messages are deleted. History data is not deleted. |
|---------|-------------------------------------------------------------------|-------------------------------------------------------------------------------------------------------------------------------------------------------------------------------------------------------------------------------------------------|

---

## Notes

### Mounting

You can mount the web server in a panel, distribution box, or on a wall. Include space for wiring when planning. Make sure service can easily access the unit and the unit is ventilated properly.

- |                           |                             |
|---------------------------|-----------------------------|
| • Standard mounting       | On standard rail TH 35-7.5. |
| • Wall mounting.          | Attached with 2 screws.     |
| • Mounting position       | Horizontal or vertical.     |
| • Mounting and dimensions | See "Dimensions".           |

### Install

#### Important notes

Observe the following when installing:

- Run fuses, switches and wiring as per local regulations for electrical installations.
- We do not recommend plant monitoring via USB interface in environments with strong electromagnetic interference (e.g. in industrial environments with electrical welding equipment).
- See "Technical data" for electromagnetic compatibility.

#### Operating voltage

The supplied AC 230 V power supply provides the DC 24 V operating voltage for the web server.

#### Wiring

The operating voltage, USB and Ethernet plugs are located on the upper part of the housing.  
The terminals on the device for the LPB/BSB bus are located under the removable cover.

#### Connection terminals

The connection terminals are designed for wire diameters of min. 0.5 mm or cross-sections of 0.25...1.5 mm<sup>2</sup> or stranded wire cross-sections of 0.25...1.0 mm<sup>2</sup>.

## Commissioning

Connections	<p>Web-Server is commissioned <b>directly via the portal</b> with a PC/Laptop. A web browser required on the PC/Laptop.</p> <p>The web server can be commissioned <b>locally via USB or with ACS790</b>. The supplied USB cable type A – Type Mini-B connects the web server to the PC/laptop.</p> <p>A quick commissioning mode is available on plants with only a single connected controller. Press the button to add a controller to the device list with address 0.1 (LPB) or 1 (BSB) and generate its device web page.</p> <p>Additional information is available in the Mounting instructions M5712 inserted in the package or the Installation guide G5712 and commissioning instructions C5712, available in the Download Center at: <a href="http://www.siemens.com/ozw672-manual">http://www.siemens.com/ozw672-manual</a>.</p>
Router	<p>You need a suitable router for remote operation via Internet. The router must support NAT/PAT to access via the portal or via a direct connection using a fixed IP address. For a direct connection using a dynamic IP address, it must also support a dynamic DNS server.</p>
IP address	<ul style="list-style-type: none"><li>• The IP address via USB is set: <b>192.168.250.1</b>.</li><li>• Default setting for the IP address via Ethernet: <b>192.168.2.10</b>.</li><li>• The network administrator must provide an IP address for the web server before you can connect the web server via Ethernet to a managed network.</li></ul>
<b>User groups</b>	<p>User accounts are created and assigned to specific user groups for customized user operation.</p>
End-user	<ul style="list-style-type: none"><li>• Access to end-user data and fault overview.</li><li>• Operate and monitor via menu tree and plant diagrams.</li><li>• Administer own user accounts.</li></ul>
Technical service	<p>Same as end user. In addition:</p> <ul style="list-style-type: none"><li>• Access service data.</li><li>• Create, download, and manage trend data</li><li>• Download consumption data and message history.</li><li>• Upload customized logos and documents.</li><li>• System definitions update.</li><li>• Firmware update</li><li>• Update device web pages.</li></ul>
Administrator	<p>Same as service. In addition:</p> <ul style="list-style-type: none"><li>• Edit device list.</li><li>• Create device web pages.</li><li>• Create, copy, change, and delete plant diagrams.</li><li>• Select "Energy indicator" data points and change the default values of the data points and/or "Green limits" as needed.</li><li>• Administer all user accounts.</li></ul>



## Maintenance

The OZW672... web server is maintenance free (no battery changes, no fuses).  
Clean the housing only with a dry towel.

## Repair

The OZW672... web server cannot be repaired on site. If faulty, return to the  
Repair Center at the relevant Regional Company.

## Disposal

---



The device is considered electrical and electronic equipment for disposal in terms  
of the applicable European Directive and may not be disposed of as domestic  
garbage.

- Use only proper channels to dispose the device.
- Comply with all local, applicable laws and regulations.

## Technical data

Power cable for web server OZW672...	Operating voltage	AC 230 V ± 15 %
	Rated voltage "Euro plug"	AC 230 V EN 50075 and VDE 0620-1
	Frequency	50/60 Hz
	Power consumption (including web server OZW672...)	3 VA typical
	Protection class	II.
	Output voltage	SELV 24 VDC
	Supply line fusing	Max. 16 A
	Cable length (distance from AC 230 V plug to web server)	Max. 1.6 m
Web server OZW672...	Operating voltage	SELV 24 VDC ± 5 %, 625 mA max.
	Power consumption	2 W typical
Functional data	Clock reserve	Min. 72 hours
	Device list	
	OZW672.01 OZW672.04 OZW672.16	1 LPB/BSB device Max. 4 LPB devices Max. 16 LPB devices
LPB/BSB bus	Interface type	2-wire connection
	2-wire bus	DB/CL+, MB/CL- (non-exchangeable)
	Bus load	E 5
	Permissible line length and cable types	See: Local Process Bus, System engineering, Basic documentation P2370
USB	Connection, screw terminals for	
	Solid/stranded wire (twisted or with ferrule)	Min. dia. 0.5 mm
	1 solid wire per terminal	0.25...1.5 mm <sup>2</sup>
	1 stranded wire per terminal	0.25...1.0 mm <sup>2</sup>
Ethernet	Interface type	100BaseTX, IEEE 802.3 compatible
	Bit rate	Max. 100 Mbps
	Protocol	TCP/IP
	Identification	Auto MDI-X
Directives and standards	Connection, plug	RJ45 plug (screened)
	Cable type	Standard Cat-5, UTP or STP
	Cable length	Max. 100 m
	Product standard	EN 60950-1 Information technology equipment – Safety
Environmental compatibility	EU conformity (CE)	CE1T5711xx <sup>*)</sup>
	RCM conformity	CE1T5711en_C1 <sup>*)</sup>
	EAC conformity	Eurasia conformity
	The product environmental declaration CE1E5711en <sup>*)</sup> contains data on environmentally compatible product design and assessments (RoHS compliance, materials composition, packaging, environmental benefit, disposal).	
Degree of protection	Protective category	IP30 to EN 60529
	Protection class	III as per EN 60950-1

\*) The documents can be ordered at <http://siemens.com/bt/download>.

Degree of protection	Protective category	IP30 to EN 60529
	Protection class	III as per EN 60950-1
Ambient conditions	Operation	IEC 60721-3-3
	Climatic conditions	Class 3K5
	Temperature (housing and electronics)	0...50 °C
	Humidity	5...95 % r. h. (non-condensing)
Mechanical conditions	Class 3M2	
Transport	Climatic conditions	IEC 60721-3-2
	Temperature	Class 2K3
	Humidity	-25...+70 °C
	Mechanical conditions	<95 % r. h. Class 2M2
Materials and colors	Upper housing section	PC + ASA, RAL 7035 (light-gray)
	Lower housing section	PC + ASA, RAL 5014 (dove blue)
Dimensions	Length x width x height (max. dimensions)	87.5 mm x 90.0 mm x 39.2 mm
Weight	Web server OZW672...	0.136 kg
	Web server with packaging, installation instructions, power unit, USB and Ethernet cable, cable ties.	0.589 kg
	Packaging	Cardboard box
Terms, abbreviations	Auto Medium Dependent Interface - Crossed	Auto-MDI(X)
	Boiler System Bus	BSB
	Dynamic Domain Name System	DynDNS
	Dynamic Host Configuration Protocol	DHCP
	HVAC Integrated Tool von Siemens	HIT
	Hyper Text Transfer Protocol	HTTP
	Hyper Text Transfer Protocol Secure	HTTPS
	Internet Protocol	IP
	Local Process Bus	LPB
	Network Address Translation	NAT
	Network Time Protocol	NTP
	Port and Address Translation	PAT
	Remote Network Driver Interface Specification	RNDIS
	Shielded Twisted Pair	STP
	Simple Mail Transfer Protocol	SMTP
	Transport Layer Security	TLS
	Transmission Control Protocol	TCP
	Universal Serial Bus	USB
	Unshielded Twisted Pair	UTP
	Web Application Programming Interface	Web API

## Connection diagrams

### Connection diagram

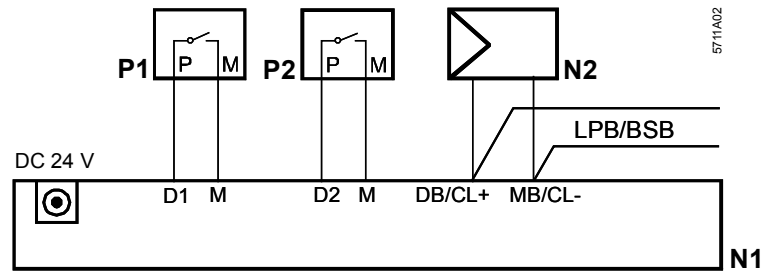

- N1 Web server  
 N2 LPB/BSB device  
 P1, P2 Devices with potential-free contact output for fault indication

### Connection terminals

LPB/BSB bus  
 Digital inputs

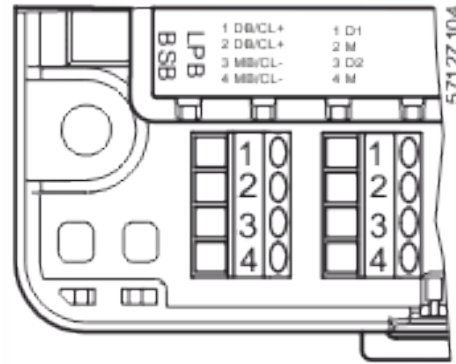

LPB/BSB	Digital
1 DB/CL+	1 D1
2 DB/CL+	2 M
3 MB/CL-	3 D2
4 MB/CL-	4 M

Operating voltage  
 DC 24 V

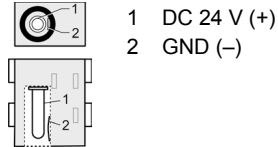

### Dimensions

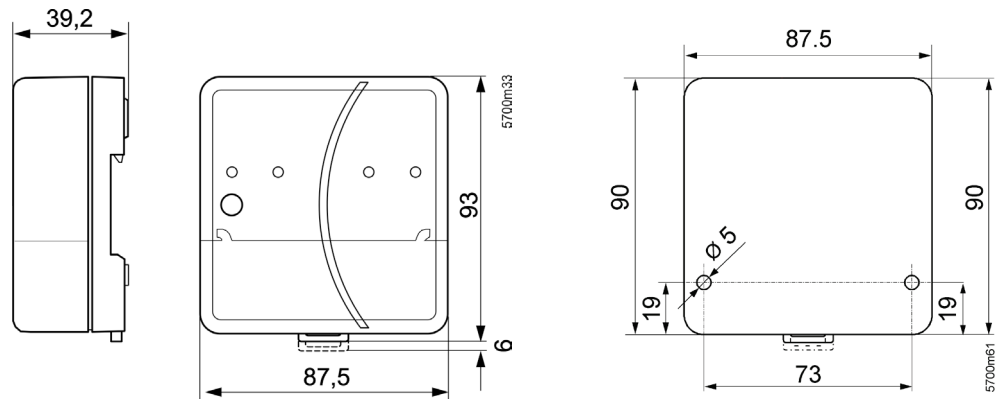

Published by:  
 Siemens Switzerland Ltd.  
 Building Technologies Division  
 International Headquarters  
 Theilerstrasse 1a  
 6300 Zug  
 Switzerland  
 Tel. +41 58-724 24 24  
[www.siemens.com/buildingtechnologies](http://www.siemens.com/buildingtechnologies)

© Siemens Switzerland Ltd 2018  
 Delivery and technical specifications subject to change